

# ZANUSSI

 Electrolux

## WASHING MACHINE ZWF 1651W

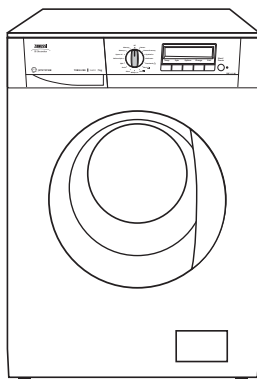

 Quick Installation Guide:

visit our WEB SITE to view an install video

[www.video.uk.electrolux.com](http://www.video.uk.electrolux.com)



# Important Safety Information

It is most important that this instruction book should be retained with the appliance for future reference. Should the appliance be sold or transferred to another owner, or should you move house and leave the appliance, always ensure that the book is supplied with the appliance in order that the new owner can get to know the functioning of the appliance and the relevant warnings.

These warnings have been provided in the interest of safety. You **MUST** read them carefully before installing or using the appliance.

## Installation

- This appliance is heavy. Care should be taken when moving it.
- It is dangerous to alter the specifications or attempt to modify this product in any way.
- All packing and transit bolts must be removed before use. Serious damage can occur to the product and to property if this is not adhered to. See relevant section in instructions.
- Any plumbing work required to install this appliance should be carried out by a qualified plumber or competent person.
- Any electrical work required to install this appliance should be carried out by a qualified electrician or competent person.
- Care must be taken to ensure that the appliance does not stand on the electrical supply cable.
- If the machine is situated on a carpeted floor, please adjust the feet in order to allow air to circulate freely.

## Child Safety

- This appliance is designed to be operated by adults. Children should not be allowed to tamper with the controls or play with the product.
- Pets and children have been known to climb into washing machines. Please check your drum before use.
- The glass door becomes very hot during the washing cycle. Keep children away from the vicinity of the appliance whilst it is in operation.
- Keep all packaging well away from children.
- Keep all detergents in a safe place out of children's reach.

## Use

- Always unplug the appliance and turn off the water supply after use.

- Do not overload the appliance. See relevant section in the instruction book.
- Only wash fabrics which are designed to be machine washed. If in doubt, consult the care label on the clothes.
- Before washing, ensure that all pockets are empty and buttons and zips are fastened. Avoid washing frayed or torn articles and treat stains such as paint, ink, rust, and grass before washing. Underwired bras must NOT be machine washed.
- Any objects such as coins, safety pins, nails, screws, stones or any other hard, sharp material can cause extensive damage and must not be placed into the machine.
- Garments which have been in contact with volatile petroleum products should not be machine washed. If volatile cleaning fluids are used, care should be taken to ensure that the fluid is removed from the garment before placing in the machine.
- Wash small items such as socks, laces, washable belts etc in a washing bag or pillow case as it is possible for such items to slip down between the tub and the inner drum.
- Only use the advised quantities of fabric softener. Damage to the fabric can ensue if you over-fill. Refer to the manufacturer's recommendations of quantities.
- As some duvets and eiderdowns should be washed in large commercial machines because of their bulk, please check with the manufacturer of the item before washing in a domestic machine.
- Leave the porthole door slightly ajar between washes to preserve the door seal.
- Under no circumstances should you attempt to repair the machine yourself. Repairs carried out by inexperienced persons may cause injury or serious malfunctioning. Contact your local Service Force Centre. Always insist on genuine spare parts.

# Contents

## For the User

<b>Important Safety Information</b>	2
<b>Your New Washing Machine</b>	4
<b>Description of the Appliance</b>	5
Detergent dispenser drawer	5
Child safety feature	5
<b>The Control Panel</b>	6-11
Programme information	12
<b>Operating Sequence</b>	13-16
Washing 6 kg of white cotton at 90°C	13
Load the laundry	13
Measure out the detergent and the fabric softener	13
Switch the machine on	13
Switching the machine on for the first time	13-14
Select the desired programme/fabric	14
Select the temperature	14
Select the Spin Speed, the Rinse Hold or the Night Cycle option	14
Select the desired options	14
Select the Delay Time	15
Start the programme	15
How to change a programme during its cycle	15
Cancelling a programme	15
How to open the door during the cycle of a programme	15
End of programme	16
<b>Washing Hints</b>	17-18
Which detergent?....	18
And in which form?	18

<b>Wash Care Symbols</b>	19
<b>Washing Programmes</b>	20-21
<b>Maintenance and Cleaning</b>	22-23
Descaling	22
After each wash	22
Maintenance Wash	22
External cleaning	22
Cleaning the dispenser drawer	22
Cleaning the drawer recess	22
Cleaning the pump	22-23
Cleaning the water inlet filter	23
The dangers of freezing	23
Emergency emptying out	23
<b>Something Not Working</b>	24-25
<b>Service and Spare Parts</b>	25
<b>Guarantee Conditions</b>	26
<b>For the Installer</b>	
<b>Installation Instructions</b>	27
<b>Technical Specifications</b>	27
Unpacking	28
Positioning	28
Water inlet	29
Water drainage	29-30
Levelling	30
Special conditions	30
In the interest of the environment	30-31
Electrical connection	31
Permanent connection	31

## Guide to use the Instruction Book

The following symbols will be found in the text to guide you throughout the instructions:



**Safety instructions**



**Hints and tips**



**Environmental information**

# Your New Washing Machine

Your new washing machine, which is fitted with the New Jet System, meets all modern requirements for effective treatment of laundry with low water, energy and detergent consumption.

- **The special Handwash and Silk programme** with their new delicate wash system treats your delicate items with extreme care.
- **The special Wool programme** with its new delicate wash system treats your woollens with extreme care.
- **The automatic cooling of the washing water** from 90° to 60°C before draining will prevent old drain pipes from being deformed.
- **The balance control device** ensures the machine is stable during the spin.

## Ecological hints

To save water and energy and help protect the environment, we recommend that you follow these hints:

- Adjust the quantity of detergent according to the hardness of your water supply, the amount of laundry and the degree of soiling.
- A programme without prewash is sufficient for normally soiled laundry.
- The machine works more economically if it is fully loaded.
- With adequate pre-treatment, stains and limited soiling can be removed; the laundry can then be washed at a lower temperature, so saving energy.

## In the interest of the environment

- Materials marked with the symbol  are recyclable.
- Check with your local Council or Environmental Health Office to see if there are facilities in your area for re-cycling this appliance.
- When the appliance is to be scrapped, cut off the power supply cable and make the door lock device unusable to prevent young children from being trapped inside.
- Help to keep your country tidy - use authorised disposal sites for your old appliance.

The symbol  on the product or on its packaging indicates that this product may not be treated as household waste. Instead it shall be handed over to the applicable collection point for the recycling of electrical and electronic equipment. By ensuring this product is disposed of correctly, you will help prevent potential negative consequences for the environment and human health, which could otherwise be caused by inappropriate waste handling of this product. For more detailed information about recycling of this product, please contact your local city office, your household waste disposal service or the shop where you purchased the product.

**How do we help to protect the environment?  
We use recycled paper!**

## Important



Your machine is fitted with a balance control device, which ensures the machine is stable during the spin. If the wash load appears not to have been spun sufficiently at the end of the wash cycle, because it is not evenly distributed in the drum, the balance control device may have operated. It will therefore be necessary to redistribute the wash load manually and select a spin programme. For more detailed information see the section headed "Something Not Working".

# Description of the Appliance

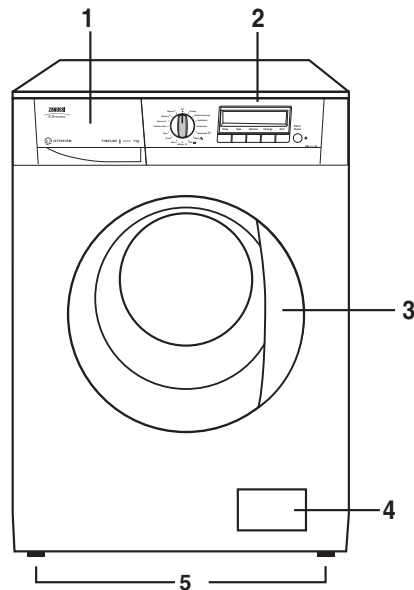
- 1 Detergent dispenser drawer
- 2 Control panel
- 3 Door opening handle
- 4 Drain pump
- 5 Adjustable feet



## Detergent dispenser drawer

-  Prewash
-  Main wash
-  Fabric softener

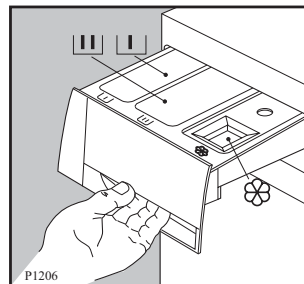

## Child safety feature

This machine incorporates a special child safety feature to prevent small children from being trapped inside the machine.

To activate this device, rotate the button (without pressing it) inside the door clockwise until the groove is horizontal. If necessary use a coin.

To disable this device and restore the possibility of closing the door, rotate the button anti-clockwise until the groove is vertical.

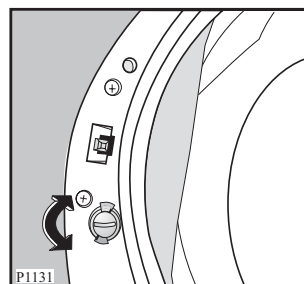

# The Control Panel

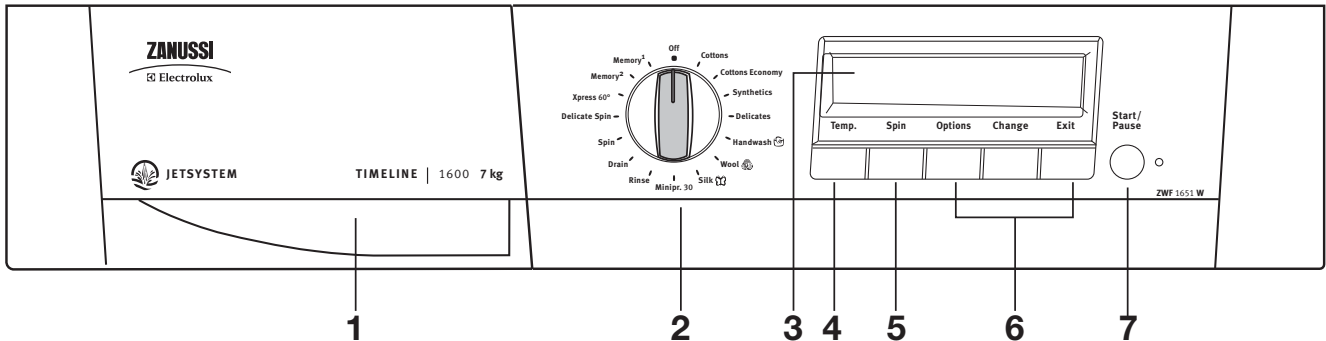

## 1 Detergent dispenser drawer

## 2 Programme selector dial

The selector dial is divided into the following sections:

- Cottons (blue colour), Synthetics (green colour) and Delicates (gray colour)
- Handwash, Wool, Silk and Minipr. 30 (gray colour)
- Rinses, Drain, Spin and Delicate Spin (gray colour)
- Xpress 60° (blue section), Memory 1, memory 2 (green section)
- **Off**

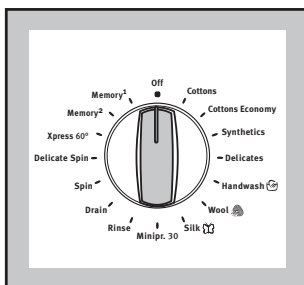

The selector dial can be turned either clockwise or anticlockwise.

Position **Cottons Economy** corresponds to the ENERGY SAVING programme for cotton and position **Off** to Reset programme/Switching off of the machine. At the end of the programme the selector dial must be turned to position **Off**, to switch the machine off .

### Attention!

If you turn the programme selector dial to another programme when the machine is working, a warning message appears for 4 seconds on the display while the buzzer sounds 3 times .

## 3 Display

The Display is used for setting a large number of functions and combine them with each other using only a few control elements (1 programme selector dial and 6 buttons). This simple control method is made easy thanks to the interactive display.

Interactive means that the washing machine display changes to reflect each step you have entered. This ensures that only those settings that make sense are made. You are able to see the current settings at any time in the information panel and in the option row.

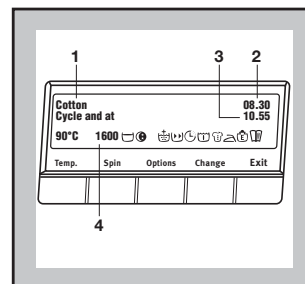

1. Information panel shows the current settings
2. Real time clock
3. End cycle time
4. Selection shows temperature, spin speed, options and extras.

## 4 Temperature button “Temp.”

Press this button repeatedly to increase or decrease the temperature, if you want your laundry to be washed at a temperature different from the one proposed by the washing machine.

Maximum temperatures are 90°C for cotton, 60°C for synthetic fabrics and Xpress 60°programme, 40°C for delicate fabrics, wool and fabrics to be hand-washed, 30°C for silk and «Minipr. 30», while «U» corresponds to cold wash.

By depressing Temperature **Temp.** button, the relevant message will appear on the second row of the display (instead of «cycle end at»). In the corner of the third row appears the indication of the selected temperature.

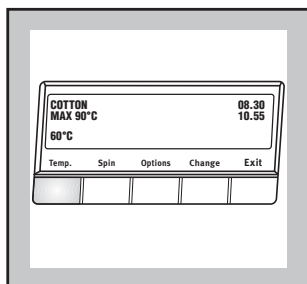

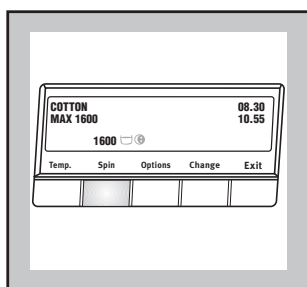

## 5 Spin speed button “Spin”

Press this button repeatedly to change the spin speed, if you want your laundry to be spun at a speed different from the one proposed by the washing machine.





Maximum speeds are:

- for cotton: 1600 rpm
- for synthetic, wool, and fabrics to be handwashed: 900 rpm;
- for delicate, silk fabrics, miniprogramme: 700 rpm;

By depressing the Spin speed button you can also choose **No Spin** option «D», **Rinse Hold** option  and **Night cycle** option .

**No spin** «D» option eliminates all the spin phases and increases the number of rinses for cottons and synthetics.

**Rinse hold** position : when you choose this option, the machine will not drain the water of the last rinse, so as not to crease the laundry.

**Night cycle** position : when you choose this option, the machine will not drain the water of the last rinse, so as not to crease the laundry.

As all spinning phases are suppressed, this washing cycle is very quiet and it can be selected at night or in times with a more economical power rate.

On cotton and synthetic programmes the rinses will be performed with more water.

To complete the cycle, choose one of the following programmes:

- **Drain**

To drain the water select **Drain** programme by means of the selector dial, then press the **Start/Pause** button.

- **Spin**

To spin the laundry choose **Spin** or **Delicate Spin** programme by means of the selector dial; select spin speed by means of **Spin** button and then press the **Start/Pause** button.

### Important!

Before choosing the programme **Drain**, **Spin** or **Delicate Spin** the selector dial has to be positioned on **Off**.

## 6 «Options», «Change» and «Exit» buttons

**Options** button allows you to move through the option icons.

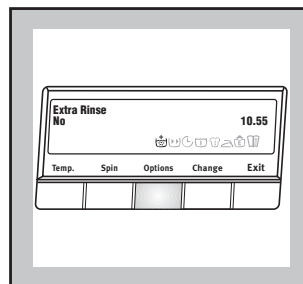

**Change** button allows you to select/change the status of the different icons.

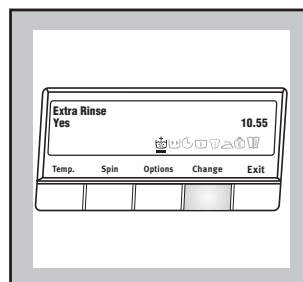

**Exit** button allows you to return to the previous selection.

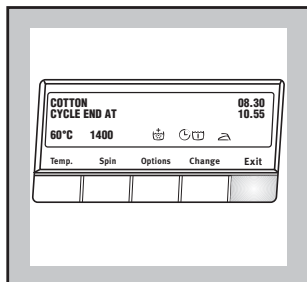

Depending on the programme, different functions can be combined. These must be selected after choosing the desired programme and before depressing the **Start/Pause** button.

By depressing the **Options** button, all the symbol icons, allowed for the selected programme will appear in the display.

The first option  will start flashing. Its name and status will appear in the display.

If you want to change the option status, press **Change** button. A line will appear below the selected icon, indicating that the option is set.

To select the other options press again the **Options** button and proceed as before.

Once you have completed the selection of the options, pressing the **Exit** button, the selected icons will remain fixed in the display.

**Note:** To modify the already chosen option selections, repeat the previous procedure.

**Important!** While selecting the option, if you press the temperature **Temp.**, **Spin**, or **Start/Pause** button, the relative function will be executed.

 **EXTRA RINSE:** this option can be selected with all programmes, except the wool/handwash programmes and miniprogramme. The machine will add 2 rinses for cottons and 1 rinse for synthetics, delicates and silk. This option is recommended for people who are allergic to detergents, and in areas where the water is very soft.

 **TIME SAVING:** this option can be used for lightly soiled cotton, synthetic or delicates items in order to obtain a good washing programme in a short time. The washing time will be reduced according to the type of fabric and the selected temperature. Selecting this option «Short» or «Very Short» will be shown in the display.

 **DELAY START:** this option makes it possible to delay the start of the washing programme by 30 min - 60 min - 90 min, 2 hours and then by 1 hour till 20 hours. The delay you have selected is indicated in the display.

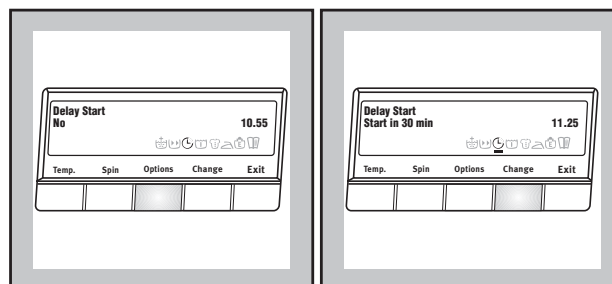

You must select this option after you have set the programme and before you press the **Start/Pause** button.

You can cancel the delay time at any moment, before you press the **Start/Pause** button. If you have already pressed the **Start/Pause** button and you wish to cancel the Delay time proceed as follows:

1. set the washing machine to PAUSE by pressing the **Start/Pause** button;
2. deselect the Delay start option, changing the status;
3. press the **Start/Pause** button to start the programme.

### **Important!**

The selected delay can be changed only after selecting the washing programme again.

The door will be locked throughout the delay time. If you need to open the door, you must first set the washing machine to PAUSE by pressing the **Start/Pause** button. After you have closed the door, press the **Start/Pause** button again.

The Delay Start **cannot** be selected with **Spin**, **Delicate Spin** and **Drain** programmes.

 **PREWASH:** select this option if you wish your laundry to be prewashed before the main wash (not available for wool and handwash cycle, Minipr. 30 and silk).

The prewash phase ends with a short spin at 650 rpm in programmes for cotton and synthetic fabrics, whereas in the programme for delicate fabrics the water is only drained.

 **INTENSIVE:** for heavy soiled laundry. This option can be selected only for cottons and synthetics. The washing time will be prolonged according to the



cycle temperature and the fabric type.

**EASY IRON:** selecting this button the laundry is gently washed and spun to avoid any creasing. In this way ironing is easier. Furthermore the machine will perform 6 rinses instead of 3 for cotton and 4 rinses instead of 3 for synthetics. This function can be used for cotton and synthetic fabrics. If this option is selected for cotton programmes, the spin speed automatically will reduce to 1000 rpm.

**ECONOMY:** this option can be selected only for synthetics lightly or normally soiled with a temperature of 40°C or higher. The washing time will be prolonged. If you select 60°C - 50°C - 40°C, the washing temperature will be reduced to 42°C.

**MENU:** Menu option is used for selecting various basic settings without affecting the particular wash programme. These basic settings will remain active until they are deselected/modified.

**Selecting MENU Options:** sound, rinse +, language, contrast or brightness.

1. Select a programme in order to turn the appliance on.
2. Press **Options** button repeatedly until the symbol flashes.
3. Press **Change**

**Note:** digital instructions are displayed if you wait 3 seconds after displaying each option in this menu.

4. Press **Options** repeatedly until the required option choice is displayed.
5. Press **Change** to select the desired option.
6. Press **Exit** to return to the set programme.

## Memory

Programme settings that are frequently used can be saved (e.g. cotton, 60°C, 1400 rpm, with time saving). There are 2 memory spaces available for this purpose. The saved programme can be selected in the same way as any other wash programme by means of the selector dial.

Example: Cotton , 60°C, 1400 rpm, with **Time saving** option.

1. Select the cycle and programme settings.

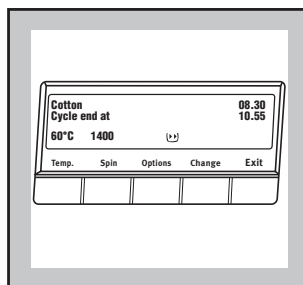

2. Enter the **Menu** option and select one of the memory positions. A «Store programme?» message will appear in the display.

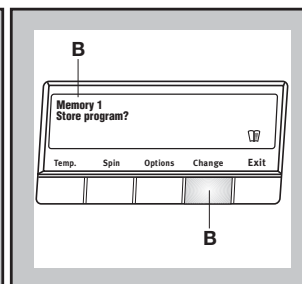
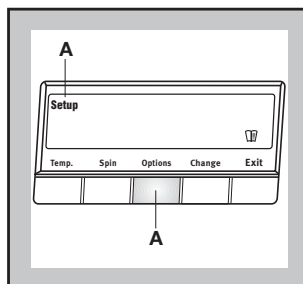

3. To memorise the selected programme press the **Change** button. «Stored» message will appear in the display.

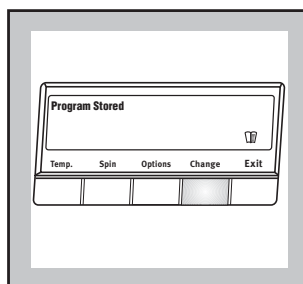

To change the memorised programme setting repeat the procedure from the beginning.

**Note:** once there is information saved in the memory it cannot be deleted. However, it can be overwritten/changed.

## SOUND

The sound setting permits you to modify the function. You can choose between different levels: low, no sound and normal.

Example:

1. Enter the **Menu** option and select the sound setting.

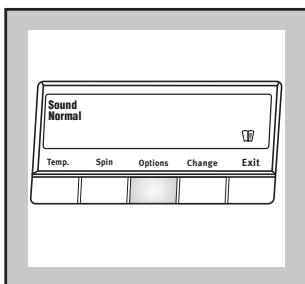

2. Use the **Change** button to select the desired level.

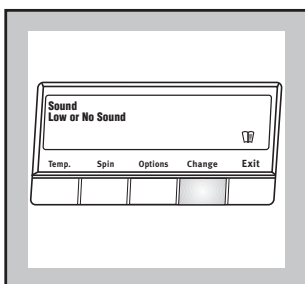

## RINSE +

The washing machine is set such that its water consumption is extremely economical. For people with allergies and in areas where the water is very soft, it can however be helpful to use more water when rinsing. When you select “**Rinse +**”, 2 additional rinses will be carried out for cottons and 1 additional rinse for synthetics, delicates and silk items. If “**Rinse +**” has been selected,  will appear in the option row.

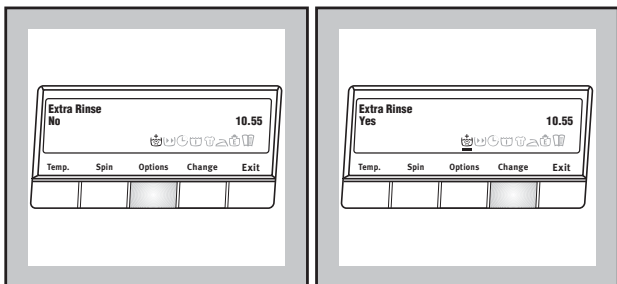

## LANGUAGE

You can change the language setting if you would like the indicators in the display to appear in a different language.

Example:

1. Enter the **Menu** option and select the Language setting.

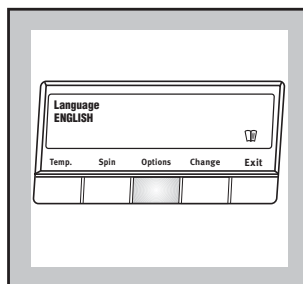

2. Press the **Change** button to select the desired Language.

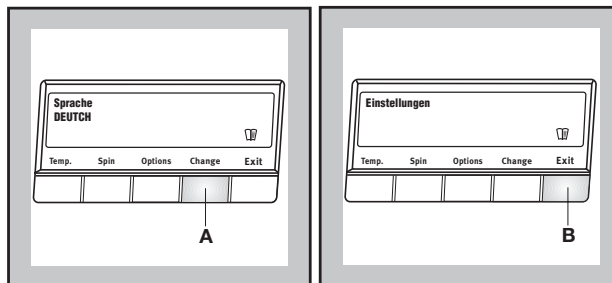

## CLOCK

The clock setting permits you to modify/set up the current time. It is important to keep it updated as the current END Cycle Time depends on it.

Example:

1. Enter the Menu option and select the Clock setting.
2. With a short/single time pressure of the **Change** button, the time varies minute by minute. With a continued pressure of the **Change** button, the time varies 10 minutes by 10 minutes.

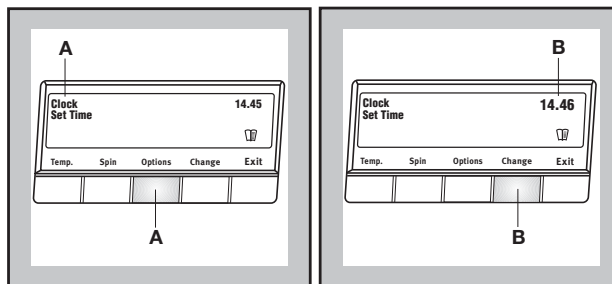

## CONTRAST

The Contrast setting allows you to modify the optical characteristic of the display.

Example:

1. Enter the **Menu** option and select the Contrast setting.
2. Use the **Change** button to set up the desired contrast level.

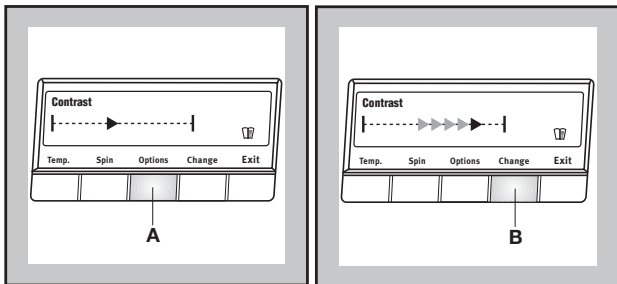

## BRIGHTNESS

The Brightness setting allows you to modify the backlight intensity of the display.

Example:

1. Enter the **Menu** option and select the Brightness setting.
2. Use the **Change** button to set up the desired brightness level.

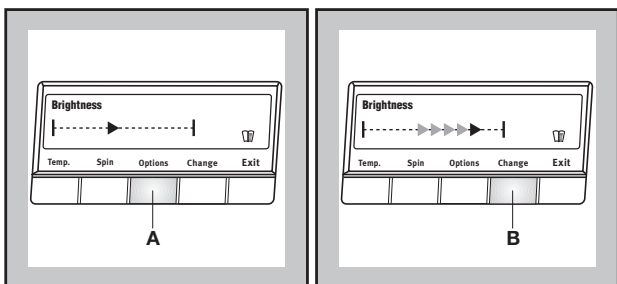

### Note:

At the end of the programme if no button is pressed for approximately 10 minutes the backlight intensity goes off.

## 7 START/PAUSE button

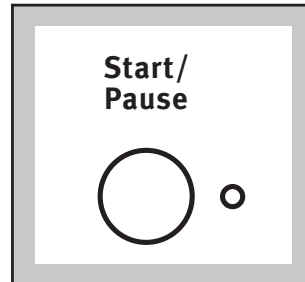

This button has 2 functions:

- **Start:** after you have selected the desired programme and options, press this button to start the washing machine. The light close to the button will stop flashing and remain lit.

If you have selected a delay time option, the countdown will begin and will be shown on the display.

- **Pause:** when you press this button again, the programme in progress is interrupted. The light close to the button will start flashing. To restart the programme, press the button again.

When you PAUSE the cycle, it becomes possible to open the door if:

- The washing machine is not in the heating phase;
- The level of the water is not high;
- The drum is not turning.

### Important!

You must set the washing machine to PAUSE before you make any change in the programme in progress.

## PROGRAMME INFORMATION



### Wool

Washing programme for machine washable wool  as well as for hand washable woollens and delicate fabrics with the “hand washing” care symbol.

### Rinse

With this programme it is possible to rinse and spin garments which have been washed by hand. The machine performs 3 rinses, followed by a final spin at maximum speed. The spin speed can be reduced by depressing **Spin** button. The final spin is foreseen only for cotton items as in the spin programme.

### Drain

For draining out the water of the last rinse in programmes with the Rinse hold  or Night cycle option . First turn the programme selector dial to **Off**, then select the **Drain** programme and depress the **Start Pause** button.

### Spin

Separate spin at maximum speed for hand washed garments. Use this for cotton items. You can reduce the speed by means of **Spin** button to adapt it to the fabrics to be spun.

### Delicate Spin

Separate spin at max. 700 rpm. speed for hand washed garments. Use this for synthetic, delicate, wool/handwashed, silk items. You can reduce the speed by means of **Spin** button to adapt it to the fabrics to be spun.

### Xpress 60°

This is a complete programme to be used for half load of slightly or normally soiled cotton items. This programme performs the A-class washing efficiency in a short time.

It can be selected with the following options: spin speed reduction, no spin, rinse hold, extra rinse and delayed start.

Max load: 3 kg

Washing temperature: 60° C

Duration of the programme: 45 min.

Final spin speed: 1200 r.p.m.

### Minipr. 30

**This is a complete programme** that can be combined with the following options: spin speed reduction, no spin, rinse hold or night cycle, delayed start.

To be used for laundry which is lightly soiled or which needs freshening up.

Max load 3 kg.

Washing temperature 30°C

Programme duration: 31 minutes

Final spin speed 700 r.p.m.

### Off/Canceling

To reset a programme and to switch off the machine turn the selector dial to **Off**. Now can a new programme be selected. A new programme can now be selected.

# Operating Sequence

Before the first wash, we recommend that you run a cotton cycle at 90°C, without any laundry in the machine, to remove any manufacturing residue from the drum and tub.

Pour 1/2 a measure of detergent into the dispenser drawer and start the machine.

## WASHING 6 KG OF WHITE COTTON AT 90°C

Suppose you have 6 kg of heavy soiled laundry to wash. It is white cotton and is suitable for high temperature washing.



### 1. Load the laundry

Open the door by carefully pulling the door handle outwards.

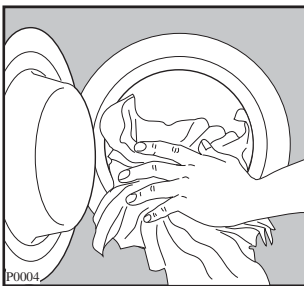
Place the laundry in the drum, one item at a time, shaking them out as much as possible. Close the door.



### 2. Measure out the detergent and the fabric softener

Pull out the dispenser drawer until it stops. Measure out the amount of detergent required, pour it into the main wash compartment  and, if you wish to carry out the prewash phase, pour it into the compartment marked . If required, pour fabric softener into the compartment marked  (the amount used must not exceed the "MAX" mark in the drawer). Close the drawer gently.

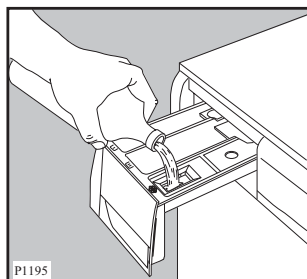
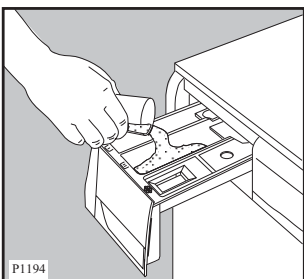

### 3. Switch the machine on

Turn the selector dial to the desired programme to switch the appliance on.

To switch the appliance off turn it to **Off**.

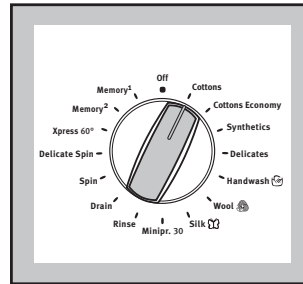

### Switching the machine on for the first time

#### LANGUAGE

When switching on the appliance for the first time you must set the language in which you want the indicators in the display to appear.

#### Important!

If the display is not showing any language, the appliance has already been switched on once. In such case, go to the chapter «Change language» if you would like to change the language setting.

Example:

1. Press the **Change** button until the desired language appears in the display.

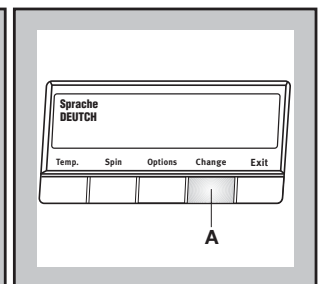
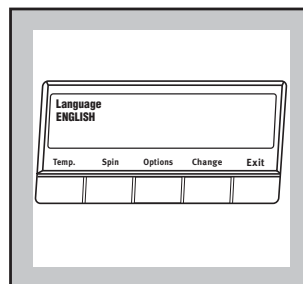

2. Press the **Exit** button to confirm the selection.

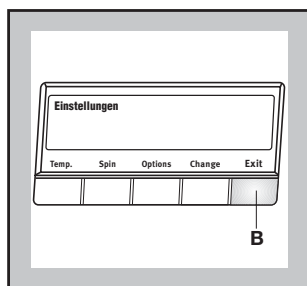

All indicators in the display will appear in this language from now on.

**Note:**

If the undesired language has been set, press simultaneously **Spin + Options** buttons for about 3 seconds in order to change the language. Follow the instructions as before.

**SETTING THE TIME**

You should set the time prior to the first wash and when changing to and from daylight savings time. See «Clock setting», Menu.

**5. Select the desired programme / fabric**

Turn the selector dial, in order to select the desired programme/fabric. The relevant message will appear in the display.

The display will show the **END CYCLE TIME** of the selected programme, calculated on the basis of the maximum load for each type of fabric. The **Start/Pause** button light will start flashing.

If the load of laundry to be washed is small, at the beginning of the cycle the display will still indicate the **END CYCLE** relevant to the maximum load. The duration value will be gradually adjusted during the execution of the cycle.

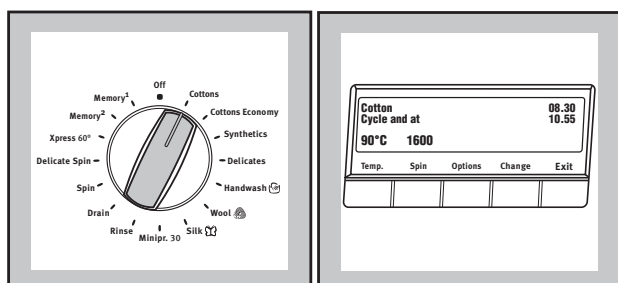



**6. Select the temperature**

Press the **Temp.** button if you wish to select a temperature value different from the one proposed by the washing machine.

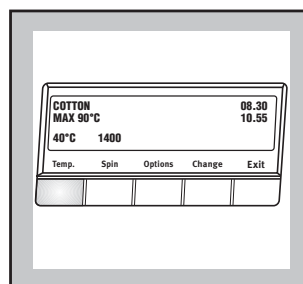
The message of the maximum available temperature appears on the second row of the display (instead of «cycle end at»). In the corner of the third row appears the indication of the selected temperature.



**7. Select the Spin Speed “Spin”, the Rinse Hold  or Night cycle **

Press the **Spin** button repeatedly, in order to select the desired spin speed or **No Spin**  or the **Rinse Hold**  or the **Night Cycle**  options. The relevant message will appear on the second row of the display. The selected spin level will be shown on the third row next to the spin button.

If you select the **Rinse Hold** or **Night Cycle** options, the machine will stop at the end of the programme with the water still in the tub.

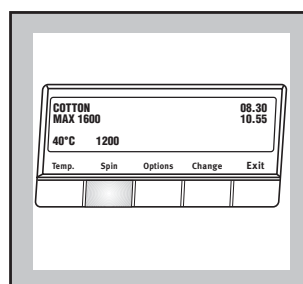

**8. Select the desired options**

Depress the relevant buttons to select the required options.

**Depending on the selected programme only certain options are available and shown during the selection phase.**

**Note:**

**Not all the options are compatible between themselves. The incompatible option icons will disappear.**

## 9. Select the DELAY TIME

Before you start the programme, if you wish the starting to be delayed, choose the DELAY option.

The selected delay time value (up to 20 hours) will appear on the display while selecting.

The end cycle will be updated and shown on the relative position of the display.

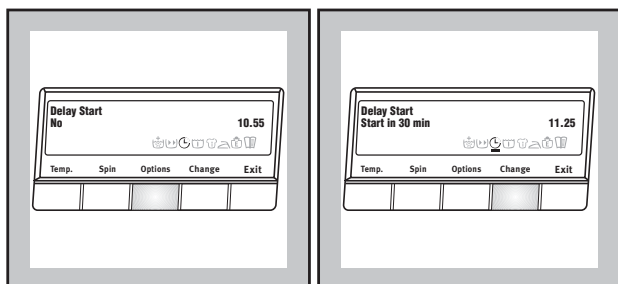

## 10. Start the programme

Press the **Start/Pause** button. The relevant light will stop flashing. The message relevant to the phase that is in progress will be shown in the display.

If you have chosen a delayed start, the washing machine will begin the countdown.

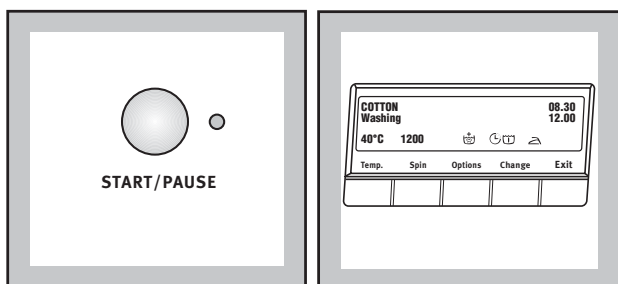

## 11. How to change an option or a programme during its cycle

If the programme has already started, before you make any change, you must pause the washing machine by pressing the **Start/Pause** button.

It is possible to change any option before the programme carries it out.

Changing a running programme is possible only by cancelling it and selecting a new programme. Turn the programme selector dial to **Off** and then to the new programme position. The washing water remains in the tub. Start the new programme by depressing the **Start/Pause** button.

**Note:** To drain the water before starting the new cycle you have to cancel the programme and select the **Drain** programme.

## 12. Cancelling a programme

Turn the selector dial to **Off** to cancel a programme which is running. Now you can select a new programme.

## 13. How to open the door during the cycle of a programme

You can open the door, after having set the washing machine to PAUSE, provided the following conditions exist:

- the washing machine is not in the heating phase beyond 55°C;
- the level of the water is not high;
- the drum is not turning.

If these requirements are met, when you pause the washing machine, the relevant message appears in the display the door can be opened.



Should it not be possible to open the door, the “**Door locked**” message appears in the display, should it be absolutely necessary to do so, switch the machine off by turning the selector dial on **Off** position.

After approximately 3 minutes, you can open the door.

**Pay attention to the level and temperature of the water in the washing machine!**

## 14. End of programme

At the end of the programme, the washing machine stops automatically, gives an audible signal (if option no sound has not been selected), and displays the relevant message.

If you had selected the  or  option, the **Start/Pause** button light is off and the “Cycle ended/Door locked” message appears in the display.

To drain or spin first turn the programme selector dial to **Off** and then to **Drain** programme or “**Spin/Delicate Spin**” programme .

Release of the lock is also indicated by the message “**Door openable**” (cycle ended) being displayed.

Turn the programme selector dial to **Off** to switch the machine off.

Remove the laundry from the washing machine.

Check whether the drum is completely empty, by rotating it with your hand. The purpose of this is to prevent any items of laundry from remaining accidentally in the drum, where they might get damaged in a subsequent wash (e.g. by shrinking) or bleed colour into another load of laundry.

We advise you to close the water supply tap and disconnect the plug from the socket.

Leave the door ajar in order to air the washing machine.



# Washing Hints

Do **NOT** overload the machine. Weigh the laundry the first few times you use the appliance.

The average weights of the most common items are listed below as a guide:

**1000g = 1 kg**

Sheet	700-1000 g
Pillow case	100-200 g
Tablecloth	400-500 g
Serviette	50-100 g
Tea towel	70-120 g
Linen hand towel	100-150 g
Towelling hand towel	150-250 g
Towelling bath towel	700-1000 g
Bath robe	1000-1500 g
Man's shirt	200-300 g
Apron	150-200 g

- Load the laundry loosely alternating large items with small ones.
- Sort the laundry according to the type of fabric, colour-fastness and how dirty it is.
- Avoid washing unhemmed or torn items as they may unravel.
- Before washing, empty all pockets of small objects which may have been left inside (coins, keys, screws etc) as these could damage the drain pump.
- When washing curtains, remove the hooks.
- Close poppers and zips and fasten loose buttons.
- It is essential to wash new coloured items separately when washing for the first time.
- When washing fabrics requiring different wash temperatures together, always select the lowest temperature.
- White items should not be washed with coloured items.
- Very small items (handkerchiefs, ribbons, socks etc) should be washed in a washing bag or a pillow case.
- Use a good quality detergent suitable for automatic washing machines.
- Use the correct quantities of detergent.
- For wool, use gentle detergent only in small quantities.
- Bleach is very corrosive; it should be used with care and kept out of reach of children.
- Some stains such as fruit, wine, grass, rust etc. are difficult to remove and should be treated before washing with specific products, which can be found in most household shops. In some cases it may help to soak the stain before washing with a special pre-soak product or biological detergent.
- Only wool marked "Pure New Wool - washable, preshrunk" can be washed in the machine using the wool programme; other types of wool should be washed in HANDWASH programme.
- If you have used the machine to wash, rinse or spin only non-colour fast garments, there may be dye left in the sump. To ensure any subsequent wash is not contaminated with the dye, select and carry out a rinse and spin programme, without any garments, to ensure that any dye is removed from the sump.
- Once you have finished using the machine, you are advised to unplug it and turn off the water tap.

## Which detergent?....

To ensure you obtain the best wash results from your appliance, it is important to use the right detergent in your everyday wash, and only detergents recommended for use in automatic machines.

To maintain the appearance of your clothes and household textiles and to make them last longer you should use different types of detergent for different washes, whether for whites, colours or delicates.

### WHITES

We recommend the Ariel product range which is biological and designed to provide excellent cleaning and stain removal even at low temperatures.



### NON BIOLOGICAL

If you prefer to use a non biological detergent, which does not contain enzymes we recommend Fairy. Fairy provides good cleaning and stain removal.



### COLOURS

For coloured items you should use a detergent which is designed to clean while maintaining the original colour. Ariel Color does not contain bleach and therefore helps to preserve colours.



### DELICATE ITEMS

When washing delicates such as woollens, you should use a product which is specially designed to care for fine fabrics.

Dreft Automatic is suitable for woollens and other delicates.



### LAUNDRY BLEACH

For additional stain removal you may wish to use a product such as Ace Gentle Bleach which is used in addition to your chosen detergent. Ace is suitable for all washable fabrics including silks, woollens and colours.



## And in which form?

Not only are there different types of detergent, but they are also available in different forms. Whether you chose a powder or liquid in traditional or compact form is your own personal choice.

### TRADITIONAL POWDERS

Pour the powder directly into the dispenser drawer. Do not sprinkle powder onto clothes in the machine drum.

### TRADITIONAL LIQUIDS

Liquid can be placed in the main wash compartment of the detergent drawer marked with the symbol , start the machine immediately upon placing the detergent in the dispenser drawer.

Alternatively the detergent is measured into the specially designed dosing device\* which should be placed on top of the laundry, and at the back of the machine drum.

### COMPACT POWDERS AND LIQUIDS

Compact detergents (or concentrates as they are also known) are available in liquid or powder form, and generally require a smaller dosage. Follow the manufacturer's instructions to ensure the most economical usage. Pour the detergent directly into the dispenser drawer, or alternatively measure the detergent into the specially designed dosing device\* which should be placed on top of the laundry, and at the back of the machine drum.

\* **If you use a dosing device in a washer dryer, please ensure the dosing device/ball is removed before carrying out a drying programme.**

### FABRIC CONDITIONERS

These are ideal for improving 'softness', and also reduce static cling on synthetics and make ironing easier. They are available in two types:

For example Lenor liquid fabric softener, for use in the **washing machine/washer dryer**. The liquid fabric softener should be poured into the compartment marked with the symbol . Follow the manufacturer's dosage instructions and never exceed the MAX level.

















Bounce conditioning sheets for use in a **tumble dryer**. We recommend the conditioning sheets are pinned (using a safety pin) to an article of laundry and placed in the tumble dryer.



# Wash Care Symbols

Wash care labels inside garments recommend how to launder your clothes with the best results. The care labelling code is in line with care labelling used in the rest of Europe. The symbols used make it easy to select the correct programme on your washing machine.

WASHING SYMBOL	WASH ACTION	FABRIC
	Normal (Maximum)	White Cotton or Linen without Special Finishes
	Normal (Maximum)	Cotton, Linen or Viscose without Special Finishes Colourfast at 60°C.
	Reduced (Medium)	Nylon, Polyester/Cotton, Viscose with Special Finishes, Cotton/Acrylic Mix.
	Normal (Maximum)	Cotton, Linen or Viscose Colourfast at 40°C but not 60°C.
	Reduced (Medium)	Acrylics, Acetate, Triacetate, Wool mixes, Polyester/wool blends.
	Much Reduced (Minimum)	Wool, wool mixtures, Silks
	Hand wash only	Do not machine wash
<b>BLEACHING</b>		
	Chlorine bleach may be used	
<b>IRONING</b>		
	Hot iron	Cotton, Linen, Viscose
	Warm iron	Polyester mixtures, Wool
	Cool iron	Acrylic, Nylon, Polyester
<b>DRY CLEANING</b>		
	May be dry cleaned. Other letters and/or a bar beneath the circle will indicate the required process to the dry cleaner.	
<b>TUMBLE DRYING</b>		
	with high heat setting	
	with low heat setting	
	May be tumble dried	
<b>X</b>	A cross through any symbol means «DO NOT»	

## Important Notes

For best results, always use the dispenser drawer for dispensing detergents and liquid additives. Once the dispenser has been filled, close it by pushing it in gently. This is particularly important if you are using

fabric conditioner to avoid the conditioner entering the machine prematurely.

When using liquid detergent and a prewash programme, place the detergent into the correct compartment in the dispenser drawer, after the prewash has finished.

# Washing Programmes







Wash programme/ Washing symbol	Type of laundry	Description	Possible options	Max. load	Progr. time mins.
<b>Cottons</b>	<b>White and coloured cotton:</b> e.g. sheets, tablecloths, household linen	Main wash at <b>0</b> (cold) - 90°C 3 rinses Long spin		6 kg	142
<b>Cottons Economy(*)</b>	<b>White and coloured cotton Economy:</b> e.g. shirts, blouses, underwear, towels, house-hold linen	Main wash at 60° - 50° - 40°C 2 rinses Long spin		7 kg	109
<b>Synthetics</b>	<b>Synthetic fabrics:</b> e.g. shirts, blouses, underwear	Main wash at <b>0</b> (cold) - 60°C 3 rinses Short spin		3 kg	88
<b>Delicates</b>	<b>Delicate fabrics:</b> e.g. acrylic fabrics, viscose, polyester, synthetic blends	Main wash at <b>0</b> (cold) - 40°C 3 rinses Short spin		3 kg	58
<b>Handwash</b> 	Special programme for hand washing fabrics	Main wash at <b>0</b> (cold)-40°C 3 rinses Short spin		2 kg	57
<b>Wool</b> 	Specially tested programme for wool garments bearing the "Pure new wool, non-shrink, machine washable" label.	Main wash at <b>0</b> (cold) - 40°C 3 rinses Short spin		2 kg	57
<b>Silk</b> 	Silk	Main wash at 30°C 3 rinses Short spin		1 kg	39
<b>Minipr. 30</b>	Special short programme for lightly soiled fabrics	Main wash at 30°C 2 rinses Short spin		3 kg	31

(\*)This programme at 60°C is the reference programme for the Energy label according to EEC Directive 92/75.

The programme times are intended as a guide only. The actual time will vary depending on incoming water temperature and pressure.

# Washing Programmes

## Special programmes

Programme dial position	Wash programme	Description	Possible options	Max. load	Progr. time mins.
<b>Rinse</b>	Separate rinse cycle for hand washed items of cotton fabric	3 rinses with liquid additive, if required. Long spin at max. speed		6 kg	48
<b>Drain</b>	For emptying out the water of the last rinses of programmes with option  or Night Cycle 	Water draining		/	2
<b>Spin</b>	Separate spin for cottons	Drain and long spin at the max. speed		6 kg	13
<b>Delicate Spin</b>	Special short programme for lightly soiled synthetic or mixed fabrics (wool, delicates and silk)	Drain and delicate spin at max 700 r.p.m.		6 kg	6
<b>Xpress 60°</b>	Special programme for half load of slightly or normally soiled cotton items	Main wash at 60°C 2 rinses Short spin at 1200 r.p.m.		3 kg	45
<b>Off</b>	For cancelling the wash programme which is running and for switching the machine off			/	-

# Maintenance and Cleaning

Before any maintenance or cleaning is carried out you must **DISCONNECT** the appliance from the electricity supply.

## Descaling

The water we use normally contains lime. It is a good idea to periodically use a water softening powder in the machine. Do this separately from any laundry washing, and according to the softening powder manufacturer's instructions. This will help to prevent the formation of lime deposits.

## After each wash

Leave the door open for a while. This helps to prevent mould and stagnant smells forming inside the appliance. Keeping the door open after a wash will also help to preserve the door seal.

## Maintenance Wash

With the use of low temperature washes it is possible to get a build up of residues inside the drum. We recommend that a maintenance wash be performed on a regular basis.

### To run a maintenance wash:

- The drum should be empty of laundry.
- Select the hottest cotton wash programme.
- Use a normal measure of detergent, must be a powder (such as Ariel Futur).

## External cleaning

Clean the exterior cabinet of the appliance with mild washing up liquid and water only, and then dry thoroughly.

## Cleaning the dispenser drawer

The washing powder and additive dispenser drawer should be cleaned regularly. Remove the drawer by pressing the catch downwards and by pulling it out. Flush it out under a tap, to remove any traces of accumulated powder. To aid cleaning, the top part of the additive compartment should be removed.

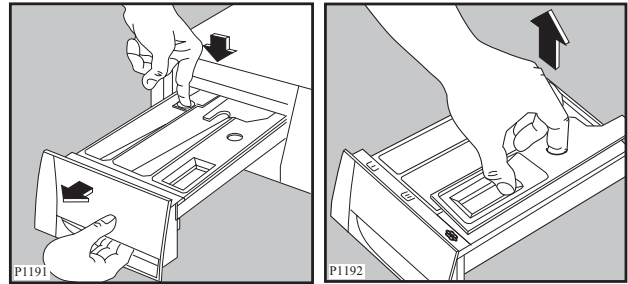

## Cleaning the drawer recess

Having removed the drawer, use a small brush to clean the recess, ensuring that all washing powder residue is removed from the upper and lower part of the recess. Replace the drawer and run the rinse programme without any clothes in the drum.

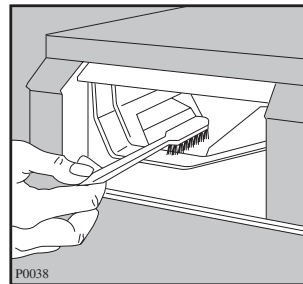

## Cleaning the pump

The pump should be inspected if

- the machine does not empty and/or spin
- the machine makes an unusual noise during draining due to objects such as safety pins, coins etc. blocking the pump.

Proceed as follows:

- Disconnect the appliance.
- If necessary wait until the water has cooled down.
- Open the pump door.

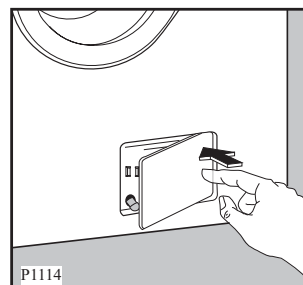

- Place a container close to the pump to collect any spillage.
- Pull out the emergency emptying hose, place it in the container and remove its cap.
- When no more water comes out, unscrew the pump

cover and remove it. Always keep a rag nearby to dry up spillage of water when removing the cover.

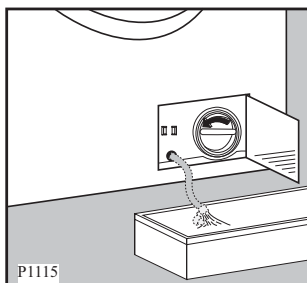

- Remove any objects from the pump impeller by rotating it.

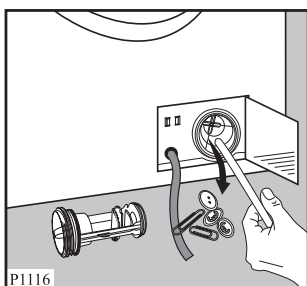

- Put the cap back on the emergency emptying hose and place the latter back in its seat.



- Screw the pump cover fully in.
- Close the pump door.

### **Warning**

When the appliance is in use and depending on the programme selected there can be hot water in the pump. Never remove the pump cover during a wash cycle, always wait until the appliance has finished the cycle, and is empty. When replacing the cover, ensure it is securely retightened so as to stop leaks and young children being able to remove it.

## Cleaning the water inlet filter

If your water is very hard or contains traces of lime deposit, the water inlet filter may become clogged. It is therefore a good idea to clean it from time to time.

Turn off the water tap. Unscrew the water inlet hose. Clean the filter using a hard bristle brush. Tighten up the inlet hose.

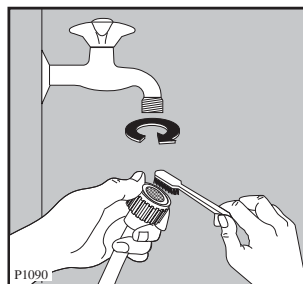

## The dangers of freezing

If the machine is exposed to temperatures below 0°C, certain precautions should be taken.

- Turn off the water tap.
- Unscrew the inlet hose.
- Place the end of the emergency emptying hose and that of the inlet hose in a bowl placed on the floor and let water drain out.
- Screw the water inlet hose back on and reposition the emergency emptying hose after having put the cap on again.
- When you intend to start the machine again, make sure that the room temperature is above 0°C.

## Emergency emptying out

If the water is not discharged, proceed as follows to empty out the machine:

- pull out the plug from the power socket;
- close the water tap;
- if necessary, wait until the water has cooled down;
- open the pump door;
- place a bowl on the floor and place the end of the emergency emptying hose into the bowl. Remove its cap. The water should drain by gravity into the bowl. When the bowl is full, put the cap back on the hose. Empty the bowl. Repeat the procedure until water stops flowing out;
- clean the pump if necessary as previously described;
- replace the emergency emptying hose in its seat after having plugged it;
- screw the pump cover again and close the door.

# Something Not Working



Certain problems are due to lack of simple maintenance or oversights, which can be solved easily without calling out an engineer. Before contacting your local Service Force Centre, please carry out the checks listed below.

During machine operation it is possible that one of the following messages appear on the display and at the same time an acoustic signal will sound:

- Problem with the water supply: **“No incoming water. Check tap & hose”**
- Problem with water draining: **“No drain. Check drain hose /filter”**
- Door open: **“Door not closed. Please check”**

Once the problem has been eliminated, press the **Start/Pause** button to restart the programme. If after all checks, the problem persists, contact your local Service Centre.

**IMPORTANT: if you call out an engineer to a fault listed below, or to repair a fault caused by incorrect use or installation, a charge will be made even if the appliance is under guarantee.**

Symptom	Possible causes
<b>The machine does not start</b>	<ul style="list-style-type: none"> <li>• The door has not been closed. (<b>“Door not closed. Please check”</b>)</li> <li>• The plug is not properly inserted in the power socket.</li> <li>• There is no supply at the socket</li> <li>• The main fuse or the fuse in the plug has blown.</li> <li>• The selector dial is not correctly positioned and the <b>Start/Pause</b> button has not been depressed.</li> <li>• The delay start has been selected.</li> </ul>
<b>The machine does not fill</b>	<ul style="list-style-type: none"> <li>• Ensure the water tap is open. (<b>“No incoming water. Check tap &amp; hose”</b>)</li> <li>• The filter in the inlet hose is blocked. (<b>“No incoming water. Check tap &amp; hose”</b>)</li> <li>• The inlet hose may be squashed or kinked. (<b>“No incoming water. Check tap &amp; hose”</b>)</li> <li>• The door has not been closed. (<b>“Door not closed. Please check”</b>)</li> </ul>
<b>The machine fills then empties immediately</b>	<ul style="list-style-type: none"> <li>• The end of the drain hose is too low.</li> <li>• The end of the drain hose is submerged in water.</li> <li>• There is no vent in the end of the drain hose.</li> </ul>
<b>The machine does not empty and/or does not spin</b>	<ul style="list-style-type: none"> <li>• The drain hose may be squashed or kinked.</li> <li>• The option ,  or No Spin “” has been selected.</li> <li>• The drain pump may be blocked.</li> <li>• The drain hose extension, if fitted, is not correct. Follow the instructions for connecting to the waste.</li> <li>• The drainage system pipes are blocked.</li> <li>• The wash load is unbalanced: redistribute the clothes inside the drum to allow the machine to spin.</li> </ul>
<b>There is water on the floor</b>	<ul style="list-style-type: none"> <li>• Too much detergent or unsuitable detergent has been used (creates too much foam).</li> <li>• Check whether there are any leaks from one of the inlet hose fittings. It is not always easy to see this as the water runs down the hose; check to see if it is damp.</li> <li>• The drain hose may be damaged or not securely positioned.</li> <li>• The detergent dispenser drawer or recess is clogged.</li> <li>• The drainage system pipes are blocked.</li> <li>• The cap on the emergency emptying hose has not been replaced after cleaning the pump.</li> </ul>



Symptom	Possible causes
Unsatisfactory washing results	<ul style="list-style-type: none"> <li>• Too little detergent or unsuitable detergent has been used. An insufficient amount of detergent leaves the laundry looking grey and causes lime scale to form.</li> <li>• Stubborn stains have not been treated prior to washing</li> <li>• The correct wash programme has not been selected.</li> <li>• Too much laundry has been placed in the drum.</li> </ul>
The machine vibrates when spinning	<ul style="list-style-type: none"> <li>• The internal packing has not been removed.</li> <li>• The machine is in contact with the wall or furniture.</li> <li>• The machine is not stable and level (check diagonally).</li> <li>• The washing load is badly distributed in the drum.</li> <li>• Maybe there is very little laundry in the drum.</li> </ul>
The door will not open	<ul style="list-style-type: none"> <li>• The programme is still running.</li> <li>• The door lock has not yet released.</li> <li>• Water in the tub: the door cannot be opened if water is present in the tub.</li> </ul> <p><b>The door can only be opened only when “Door openable” message appears in the display</b></p>
Spinning starts late or the machine does not spin	<ul style="list-style-type: none"> <li>• The electronic unbalance detection device has cut in because the laundry is not evenly distributed in the drum. The laundry is redistributed by reverse rotation of the drum. This may happen several times before the unbalance disappears and normal spinning can resume. If, after 6 minutes, the laundry is still not evenly distributed in the drum, the machine will not spin. In this case, redistribute the load manually and reselect the spin programme.</li> </ul>
No water is visible in the drum	<ul style="list-style-type: none"> <li>• Machines based on modern technology operate very economically using very little water without affecting performance.</li> </ul>

## Service & Spare Parts **SERVICE FORCE**

In the event of your appliance requiring service, or if you wish to purchase spare parts, please contact your local Service Force Centre by telephoning:

**0870 5 929929**

Your telephone call will be automatically routed to the Service Force Centre covering your post code area.

For the address of your local Service Force Centre and further information about Service Force, please visit the website at [www.serviceforce.co.uk](http://www.serviceforce.co.uk).

For Customer Service in Ireland please contact us at the address below:

Zanussi Electrolux  
Electrolux Group (Irl) Ltd  
Long Mile Road  
Dublin 12  
Republic of Ireland

Tel: +353 (0)1 4090751

Email: [service.eid@electrolux.ie](mailto:service.eid@electrolux.ie)

Before calling out an engineer, please ensure you have read the details under the heading “Something Not Working”.

When you contact the Service Force Centre you will need to give the following details:

1. Your name, address and post code
2. Your telephone number
3. Clear and concise details of fault
4. The model and serial number of the appliance (found on the rating plate - see picture)
5. The purchase date.

**Please note that a valid purchase receipt or guarantee documentation is required for in-guarantee service calls.**

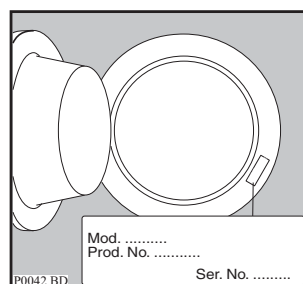

## Customer Care Department

For general enquiries concerning your Zanussi Electrolux appliance or for further information on Zanussi Electrolux products, please contact our Customer Care Department by letter or telephone at the address below or visit our website at [www.zanussi.co.uk](http://www.zanussi.co.uk)

Customer Care Department - Zanussi Electrolux

### Major Appliances

Addington Way

Luton

Bedfordshire

LU4 9QQ

Tel 08705 727727\*

\* calls to this number may be recorded for training purposes.

# Guarantee Conditions

## Standard guarantee conditions

We, Zanussi Electrolux, undertake that if, within 12 months of the date of the purchase, this ZANUSSI ELECTROLUX appliance or any part thereof is proved to be defective by reason only of faulty workmanship or materials, we will, at our option repair or replace the same FREE OF ANY CHARGE for labour, materials or carriage on condition that:

- The appliance has been correctly installed and used only on the electricity supply stated on the rating plate.
- The appliance has been used for normal domestic purposes only, and in accordance with the manufacturer's instructions.
- The appliance has not been serviced, maintained, repaired, taken apart or tampered with, by any person not authorised by us.
- All service work under this guarantee must be undertaken by a Service Force Centre.
- Any appliance or defective part replaced shall become the Company's property.
- This guarantee is in addition to your statutory and other legal rights.

Home visits are made between **8.30am** and **5.30pm** Monday to Friday. Visits may be available outside these hours in which case a **premium** will be charged.

## Exclusions

### This guarantee does not cover:

- Damage or calls resulting from transportation, improper use or neglect, the replacement of any light bulbs or removable parts of glass or plastic.
- Costs incurred for calls to put right an appliance which is improperly installed or calls to appliances outside the United Kingdom.

- Appliances found to be in use within a commercial environment, plus those which are subject to rental agreements.
- Products of Zanussi Electrolux manufacture which are NOT marketed by Zanussi Electrolux.

## European guarantee

If you should move to another country within Europe then your guarantee moves with you to your new home subject to the following qualifications:

- The guarantee starts from the date you first purchased your product.
- The guarantee is for the same period and to the same extent for labour and parts as exists in the new country of use for this brand or range of products.
- The guarantee relates to you and cannot be transferred to another user.
- Your new home is within the European Community (EC) or European Free Trade Area.
- The product is installed and used in accordance with our instructions and is only used domestically, i.e. a normal household.
- The product is installed taking into account regulations in your new country.

Before you move please contact your nearest Customer Care Centre, listed below, to give them details of your new home. They will then ensure that the local Service Organisation is aware of your move and able to look after you and your appliances.

France	Senlis	+33 (0) 344 62 29 29
Germany	Nurnberg	+49 (0) 800 234 7378
Italy	Pordenone	+39 0434 39 4700
Sweden	Stockholm	+46 (0) 8 672 53 90
UK	Luton	+44 (0) 8705 727 727
Ireland	Dublin	+353 (0) 1 4090751

# Installation Instructions

- ⚠ It is dangerous to alter the specifications or attempt to modify this product in any way.
- ⚠ Care must be taken to ensure that the appliance does not stand on the electrical supply cable.
- ⚠ Any electrical work required to install this appliance should be carried out by a qualified electrician or competent person.
- ⚠ Any plumbing work required to install this appliance should be carried out by a qualified plumber or competent person.
- ⚠ Should the appliance power supply cable need to be replaced, this should be carried out by our Service Force Centre.

# Technical Specifications

DIMENSIONS	Height Width Depth	85 cm 60 cm 63 cm
POWER SUPPLY VOLTAGE TOTAL POWER ABSORBED		230-240 V/50 Hz 2050 W (10A)
WATER PRESSURE	Minimum Maximum	0.05 MPa (0.5 bar) 0.8 MPa (8.0 bar)
MAX LOAD CAPACITY	Cotton, linen Synthetics Delicate fabrics Wool and handwash Silk	7 kg 3 kg 3 kg 2 kg 1 kg
SPIN SPEED	Maximum	1600 rpm
CONSUMPTION DATA FOR WASHING 7 KG NORMALLY SOILED COTTON ITEMS AT 60°C (PROGR. COTTONS ECONOMY)	Energy Water Time	1.19 kWh 56 litres 109 minutes

- CE This appliance complies with the following E.E.C. Directives:
- 73/23 EEC of 19.2.73 (Low Voltage Directive) and subsequent modifications;
  - 89/336 EEC of 3.5.89 (Electromagnetic Compatibility Directive) and subsequent modifications.

## Unpacking

 All transit bolts and packing must be removed before using the appliance.

You are advised to keep all the packaging for re-use in case the machine is to be transported again.

Using a spanner unscrew and remove the two rear bottom screws. Slide out the two plastic pins.

Lay the machine gently on its back, making sure that the hoses are not squashed.

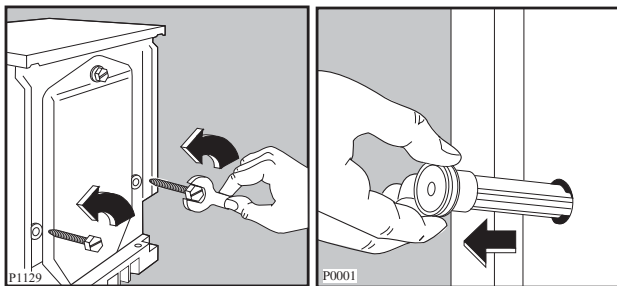

Remove the polystyrene block from the bottom of the machine and release the two plastic bags.

Very carefully slide out the left polythene bag, removing it towards the right and then downwards.

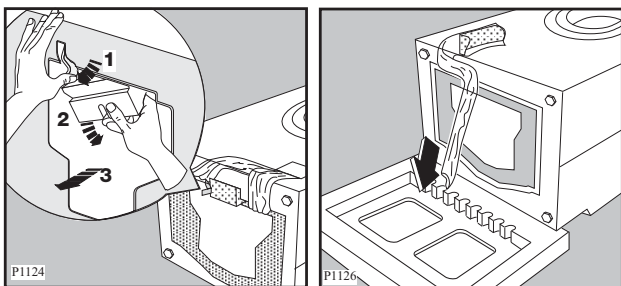

Repeat the operation for the right polythene bag, removing it towards the left and then upwards. Remove the polystyrene base

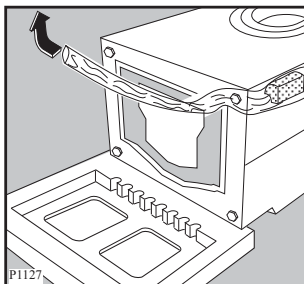

### Important!

You can find more detailed instructions regarding the bottom cover assembly in its relative bag.

Set the machine upright and unscrew the remaining rear screw. Slide out the relevant pin.

Fill all the holes with the plastic plugs supplied with the instruction booklet.

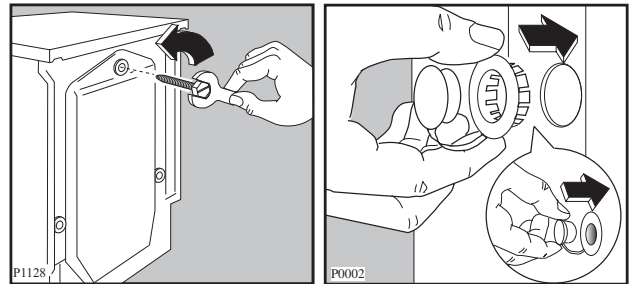

### Important !

**You are advised to keep all the packaging for re-use in case the machine is to be transported again.**

**In case of moving the same precautions as per paragraph "The dangers of freezing" must be taken i.e. the residual water in the hoses must be pumped out.**

## Positioning

Install the machine on a flat hard floor.

Make sure that air circulation around the machine is not impeded by carpets, rugs etc. Check that the machine does not touch the wall or other kitchen units.

Never place cardboard, wood or similar materials under the machine to compensate for any unevenness in the floor.

Your new washing machine has been designed to be permanently plumbed in to your home's water supply and drainage system. However, if this is not possible, it may be connected to suitable existing tap with the drain hose discharging into a sink.

The appliance has one inlet hose, with female 3/4" BSP thread connector. If this connection is not compatible with the plumbing of the existing installation, a variety of connectors are available from good hardware stores and plumbers merchants to suit most domestic plumbing. Any alteration to your existing plumbing must be carried out by a competent person, or qualified plumber.

## Installation on a Suspended Floor

Suspended wooden floors are particularly susceptible to vibration. To help prevent vibration we recommend you place a waterproof wood panel, at least 15 mm thick under the appliance, secured to at least 2 floor beams with screws. If possible install the appliance in one of the corners of the room, where the floor is more stable.

## Water inlet

Connect the hose to a tap with a 3/4" thread.  
Do not use previously used hoses for water connection.

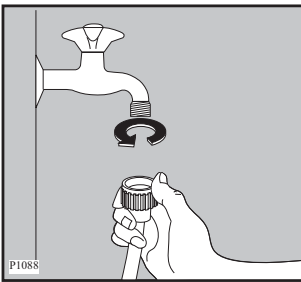

Installation should comply with local water authority and building regulations' requirements.

### The appliance must be connected to a cold water supply.

A minimum water pressure of 0.05 MPa (0.5 bar) is required for safe operation of the appliance.

If you cannot make the cold water connection direct from the rising mains, you may be able to operate the appliance from your cold water storage system.

There should be a minimum distance of 5.02m (16.5 ft) between the appliance's inlet and the bottom of the water storage tank.

Set the hose correctly by loosening the ring nut. After positioning the inlet hose, be sure to tighten the ring nut again to prevent leaks.

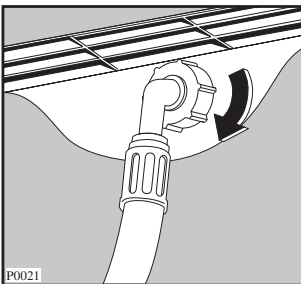

## Water drainage

This appliance is designed to be permanently plumbed into your home's drainage system using one of the following methods.

### 1. Into a drainage standpipe.

Firstly form a hook in the end of the drain hose using the "U" piece" supplied.

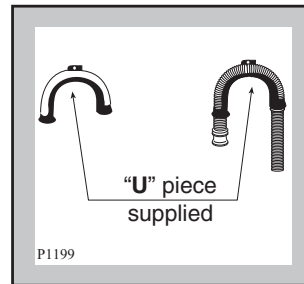

Place the drain hose into your standpipe, which should have an internal diameter of approximately 38mm thus ensuring there is an air break between the drain hose and standpipe.

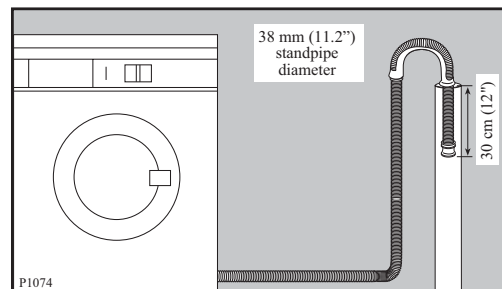

When discharging into a standpipe ensure that the top of the standpipe is no more than 90cm (35.4") and no less than 60cm (23.6") above floor level.

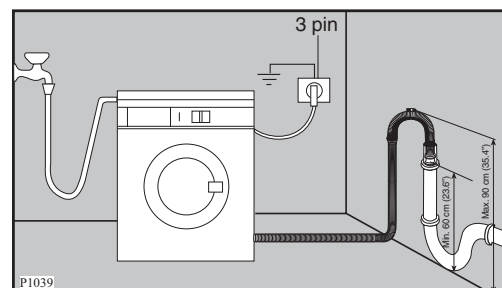

The drain hose may be extended to a maximum of 4 metres. An additional drain hose and joining piece is available from your local Service Force Centre. The joining piece must have an internal diameter of 18mm.

If your drain hose looks like this (see below) you do not require the “U” piece”. Just push the hose firmly into the standpipe.

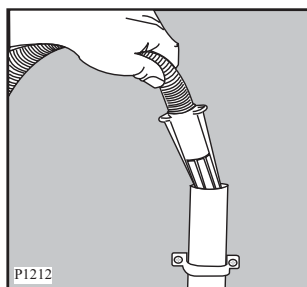

## 2. Onto a sink outlet spigot.

If the outlet spigot has not been used before, remove any blanking plug that may be in place.

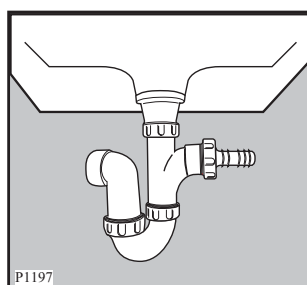

Push the drain hose onto the spigot and secure with a clip if required, ensure a loop is formed in the drain hose (see diagram) to prevent waste from the sink entering the washing machine.

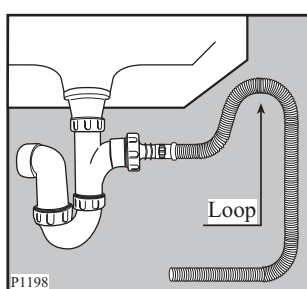

The drain hose may be extended to a maximum of 4 metres. An additional drain hose and joining piece is available from your local Service Force Centre. The joining piece must have an internal diameter of 18mm.

### Important

Before connecting up the machine to new pipework or to pipework that has not been used for some time, run off a reasonable amount of water to flush out any debris that may have collected in the pipes.

## Levelling

Level the washing machine by raising or lowering the feet. The feet may be tight to adjust as they incorporate a self locking nut, but the machine **MUST** be level and stable.

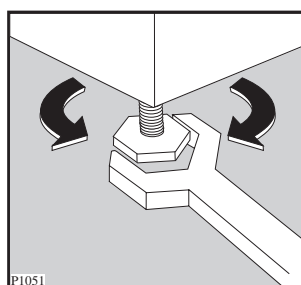

Any necessary adjustment can be made with a spanner. Accurate levelling prevents vibration, noise and displacement of the machine during operation.

Some vibration is inevitable, especially if mounted on a wooden floor. Sprung wooden floors are particularly susceptible to vibration. For advice, consult a builder. If possible, always place the machine on a solid floor.

## Special conditions

If the floor is carpeted or covered with crumbly or soft material, insert a rigid support base under the feet to prevent noise, vibration or displacement. The base should protrude a few centimetres beyond the edges of the machine.

### Warning

The machine should **NOT** be placed on deep pile carpeting.

### Note

Please ensure that when the appliance is installed it is easily accessible for the engineer in the event of a breakdown.

## In the interest of the environment

Washing machines and dishwashers should be connected to the FOUL drainage system, the water will then be taken to a sewage works for treatment before being discharged safely into a river.

It is essential that these appliances are not connected to the surface water drainage system as this water is discharged directly into a river or stream and may cause pollution.

If you require any further advice please contact your local water authority.

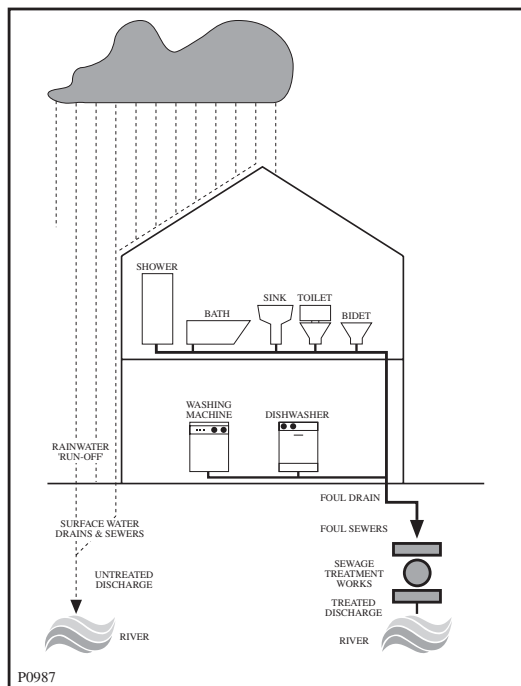

Should the plug need to be replaced for any reason, proceed as described below.

The wires in the mains lead are coloured in accordance with the following code:

- Green and Yellow - Earth
- Blue - Neutral
- Brown - Live

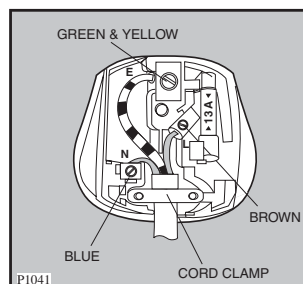

The wire coloured green and yellow must be connected to the terminal marked with the letter «E» or by the earth symbol  $\perp$  or coloured green and yellow.

The wire coloured blue must be connected to the terminal marked «N» or coloured black.

The wire coloured brown must be connected to the terminal marked «L» or coloured red.

Upon completion there must be no cut, or stray strands of wire present and the cord clamp must be secure over the outer sheath.

## Electrical connection

Any electrical work required to install this appliance should be carried out by a qualified electrician or competent person.

**WARNING: THIS APPLIANCE MUST BE EARTHED.**

**The manufacturer declines any liability should this safety measure not be observed.**

**WARNING:**  
**A cut off plug inserted into a 13 amp socket is a serious safety (shock) hazard. Ensure that the cut off plug is disposed of safely.**

Before switching on, make sure the electricity supply voltage is the same as that indicated on the appliance's rating plate. The rating plate is located at the bottom of the rim of the open door.

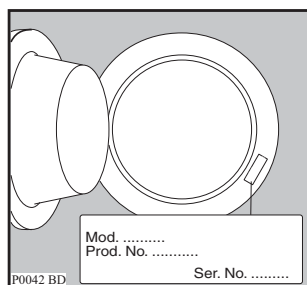

The appliance is supplied with a 13amp plug fitted. In the event of having to change the fuse in the plug supplied, a 13amp ASTA approved (BS1363A) fuse

**Should the appliance power supply cable need to be replaced, this must be carried out by our Service Force Centre.**

### Note

When the appliance is installed the power supply cable must be accessible.

## Permanent connection

In the case of permanent connection it is necessary that you install a double pole switch between the appliance and the electricity supply (mains), with a minimum gap of 3mm between the switch contacts and of a type suitable for the required load in compliance with the current electrical regulations.

The switch must not break the yellow and green earth cable at any point.

 **From the Electrolux Group. The world's No. 1 choice.**

*The Electrolux Group is the world's largest producer of powered appliances for kitchen, cleaning and outdoor use. More than 55 million Electrolux Group products (such as refrigerators, cookers, washing machines, vacuum cleaners, chain saws and lawn mowers) are sold each year to a value of approx. USD 14 billion in more than 150 countries around the world.*